

KIT PROFILI / PROFILES KIT

PROFILO 4731 - Monoemissione/Single emission

Applique
Applique

Installazione anche a sospensione e plafone.
Installation also in suspension and ceiling-wall.

Possibilità doppia StripLED.
Double StripLED option.

Possibilità alim. interno.
Internal power supply option.



INFORMAZIONI PRODOTTO:
PRODUCT INFORMATION:

Materiale profilo: Material:	Alluminio / Aluminium
Finitura: Finish:	<input checked="" type="checkbox"/> Alluminio anodizzato Anodized aluminum <input type="checkbox"/> Bianco White <input type="checkbox"/> Nero Black
Materiale diffusore: Diffuser material:	Policarbonato / Polycarbonate
Diffusore: Diffuser:	Opale - Opale alto - Prismatico UGR19 Opal - High opal - Prismatic UGR19
Contenuto kit: Kit contents:	Profilo+Diffusore+Profilo copertura+Staffe e Clip Profile+Diffuser+Cover profile+Brackets and Clips
Ambiente: Ambient:	Interno / Indoor
Emissione luce: Light emission:	Monoemissione / Single emission
Lunghezze disponibili: Available lengths:	1m - 2m - 3m - 4m
Grado IP: IP grade:	IP20

Unità: mm
Unit: mm

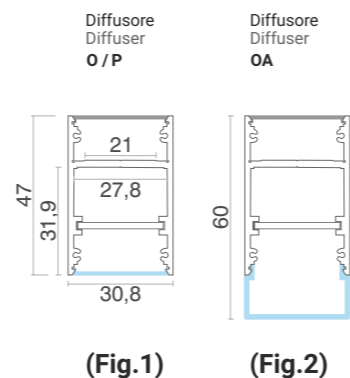

INSTALLAZIONE / INSTALLATION

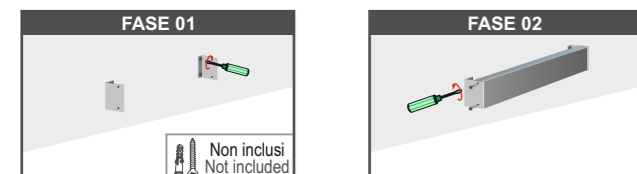

Stabilire l'interasse dei fori e fissare le staffe con le apposite viti.
Establish the center distance of the holes and fix the brackets with the special screws.

Fissare il profilo alle staffe (verificare prima la corretta accensione del profilo).
Fix the profile to the brackets (check for correctness first turning on the profile).

FISSAGGIO / FIXING

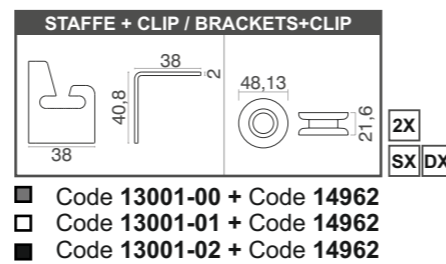

COMPOSIZIONE CODICE KIT
KIT CODE COMPOSITION

COD. BASE BASE CODE	EMISSIONE EMISSION	DIFFUSORE DIFFUSER	FINITURA FINISH	LUNGHEZZA LENGTH
4731-	ME (Monoemis./single emission)	O (opale/opal) OA (opale alto/high opal) P (prism.UGR19/prismatic)	00 (alluminio/aluminium) 01 (bianco/white) 02 (nero/black)	L10 (1000mm) L20 (2000mm) L30 (3000mm) L40 (4000mm)

Nella versione MONOEMISSIONE sarà sempre applicato il profilo di alluminio 14285 come copertura superiore.
In the SINGLE EMISSION version, the 14285 aluminum profile will always be applied as the upper cover.

OPZIONALE / OPTIONAL

15158
Kit sospensione 2 cavi L=2500mm
Suspension kit 2 cables L=2500mm

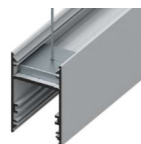

13002
Clip in ottone fiss.a plafone
Brass clip for ceiling fix



Fissare a muro la clip in ottone e successivamente fissare il profilo a scatto
CEILING
Fix the brass clip to the wall and subsequently fix the snap profile

CODICI COMPONENTI SINGOLI / SINGLE COMPONENTS CODES

PROFILO 4731 - Monoemissione/Single emission

PROFILO/PROFILE

- 14794-L10 / 14794-L20 / 14794-L30 / 14794-L40
Alluminio L=1m/2m/3m/4m
Aluminum L=1m/2m/3m/4m
- 14794-01L10 / 14794-01L20 / 14794-01L30 / 14794-01L40
Bianco L=1m/2m/3m/4m
White L=1m/2m/3m/4m
- 14794-02L10 / 14794-02L20 / 14794-02L30 / 14794-02L40
Nero L=1m/2m/3m/4m
Black L=1m/2m/3m/4m

PROFILO DI COPERTURA PER MONOEMISSIONE
COVERAGE PROFILE FOR SINGLE EMISSION

- 13006-L10 / 13006-L20 / 13006-L30 / 13006-L40
Alluminio L=1m/2m/3m/4m
Aluminum L=1m/2m/3m/4m
- 13006-01L10 / 13006-01L20 / 13006-01L30 / 13006-01L40
Bianco L=1m/2m/3m/4m
White L=1m/2m/3m/4m
- 13006-02L10 / 13006-02L20 / 13006-02L30 / 13006-02L40
Nero L=1m/2m/3m/4m
Black L=1m/2m/3m/4m

DIFFUSORE/DIFFUSER

- 14018-L10 / 14018-L20 / 14018-L30 / 14018-L40
Opale L=1m/2m/3m/4m
Opal L=1m/2m/3m/4m
- 25011-L10 / 25011-L20 / 25011-L30 / 25011-L40
Prismatico L=1m/2m/3m/4m
Prismatic L=1m/2m/3m/4m

- 25010-L10 / 25010-L20 / 25010-L30 / 25010-L40
Opale alto L=1m/2m/3m/4m
High opal L=1m/2m/3m/4m

TAPPI/CAPS

- 14834 / 14959
Alluminio: passacavo e chiuso
Aluminum: grommet and closed
- 14834-01 / 14959-01
Bianchi: passacavo e chiuso
White: grommet and closed
- 14834-02 / 14959-02
Neri: passacavo e chiuso
Black: grommet and closed

- 25012P / 25012C
Tappi alluminio: passacavo e chiuso per diffusore 14018+25010
Aluminum caps: grommet and closed for diffuser 14018+25010
- 25012P-01 / 25012C-01
Tappi bianchi: passacavo e chiuso per diffusore 14018+25010
White caps: grommet and closed for diffuser 14018+25010
- 25012P-02 / 25012C-02
Tappi neri: passacavo e chiuso per diffusore 14018+25010
Black caps: grommet and closed for diffuser 14018+25010

FISSAGGIO/FIXING

- 13001-00
Kit 2 staffe simmetriche ox. argento per fissaggio APPLIQUE.
Kit for 2 symmetrical ox. silver brackets for fixing APPLIQUE.
- 13001-01
Kit 2 staffe simmetriche bianche per fissaggio APPLIQUE.
Kit for 2 symmetrical white brackets for fixing APPLIQUE.
- 13001-02
Kit 2 staffe simmetriche nere per fissaggio APPLIQUE.
Kit for 2 symmetrical black brackets for fixing APPLIQUE.
- 14210
Clip in ottone per staffe 13001.
Brass clip for brackets 13001.

(Fig.1)

(Fig.2)

(Fig.1)

(Fig.2)

KIT PROFILI / PROFILES KIT

PROFILO 4731 - Biemissione/Biemiission

INFORMAZIONI PRODOTTO: / PRODUCT INFORMATION:

Materiale profilo: Material:	Alluminio / Aluminium
Finitura: Finish:	<input checked="" type="checkbox"/> Alluminio anodizzato / Anodized aluminum <input type="checkbox"/> Bianco / White <input type="checkbox"/> Nero / Black
Materiale diffusore: Diffuser material:	Policarbonato / Polycarbonate
Diffusore: Diffuser:	Opale - Opale alto - Prismatico UGR19 Opal - High opal - Prismatic UGR19
Contenuto kit: Kit contents:	Profilo+2 Diffusori+Dissipatore interno+Staffe e Clip Profile+2 Diffusers+Internal heatsink+Brackets and Clips
Ambiente: Ambient:	Interno / Indoor
Emissione luce: Light emission:	Biemissione / Biemiission
Lunghezze disponibili: Available lengths:	1m - 2m - 3m - 4m
Grado IP: IP grade:	IP20

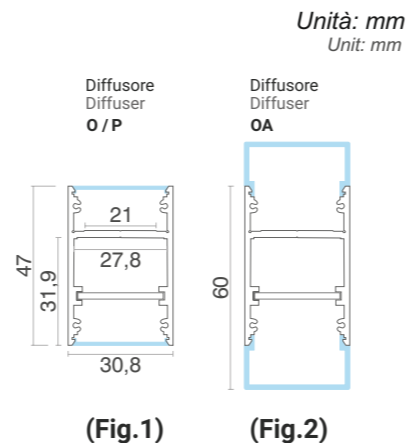
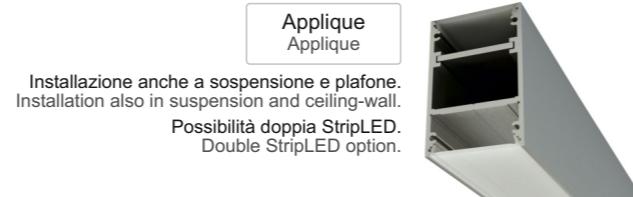

INSTALLAZIONE / INSTALLATION

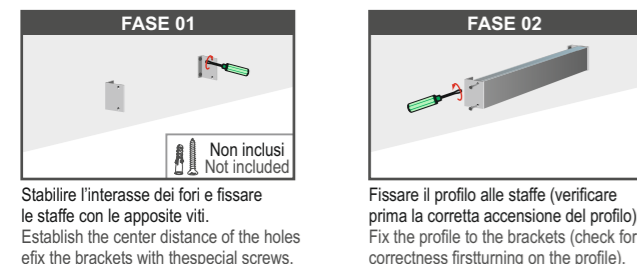

FISSAGGIO / FIXING

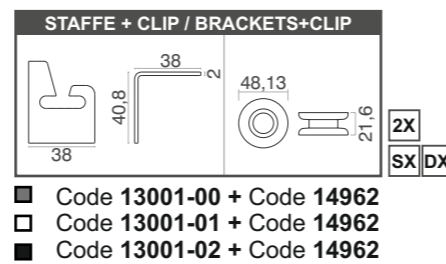

COMPOSIZIONE CODICE KIT / KIT CODE COMPOSITION

COD. BASE / BASE CODE	EMISSIONE / EMISSION	DIFFUSORE / DIFFUSER	FINITURA / FINISH	LUNGHEZZA / LENGTH
4731-	BE (Biemis./biemiission)	O (opale/opal) OA (opale alto/high opal) P (prism.UGR19/prismatic)	00 (alluminio/aluminium) 01 (bianco/white) 02 (nero/black)	L10 (1000mm) L20 (2000mm) L30 (3000mm) L40 (4000mm)

Massimo wattaggio per biemissione 16W/m. / Maximum wattage for biemiission 16W/m.

OPZIONALE / OPTIONAL

15158 Kit sospensione 2 cavi L=2500mm / Suspension kit 2 cables L=2500mm

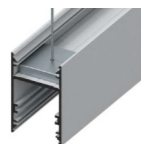

13002 Clip in ottone fiss.a plafone / Brass clip for ceiling fix



Fissare a muro la clip in ottone e successivamente fissare il profilo a scatto CEILING / Fix the brass clip to the wall and subsequently fix the snap profile

CODICI COMPONENTI SINGOLI / SINGLE COMPONENTS CODES

PROFILO 4731 - Biemissione/Biemiission

PROFILO/PROFILE

- 14794-L10 / 14794-L20 / 14794-L30 / 14794-L40 Alluminio L=1m/2m/3m/4m / Aluminum L=1m/2m/3m/4m
- 14794-01L10 / 14794-01L20 / 14794-01L30 / 14794-01L40 Bianco L=1m/2m/3m/4m / White L=1m/2m/3m/4m
- 14794-02L10 / 14794-02L20 / 14794-02L30 / 14794-02L40 Nero L=1m/2m/3m/4m / Black L=1m/2m/3m/4m

DISSIPATORE INTERNO 25x2mm / INTERNAL DISSIPATOR 25x2mm

- 14456-L10 / 14456-L20 / 14456-L30 / 14456-L40 Alluminio L=1m/2m/3m/4m / Aluminum L=1m/2m/3m/4m

DIFFUSORE/DIFFUSER

- 14018-L10 / 14018-L20 / 14018-L30 / 14018-L40 Opale L=1m/2m/3m/4m / Opal L=1m/2m/3m/4m
- 25011-L10 / 25011-L20 / 25011-L30 / 25011-L40 Prismatico L=1m/2m/3m/4m / Prismatic L=1m/2m/3m/4m
- 25010-L10 / 25010-L20 / 25010-L30 / 25010-L40 Opale alto L=1m/2m/3m/4m / High opal L=1m/2m/3m/4m

TAPPI/CAPS

- 14834 / 14959 Alluminio: passacavo e chiuso / Aluminum: grommet and closed
- 14834-01 / 14959-01 Bianchi: passacavo e chiuso / White: grommet and closed
- 14834-02 / 14959-02 Neri: passacavo e chiuso / Black: grommet and closed
- 25013P / 25013C Tappi alluminio: passacavo e chiuso per DOPPIO diffusore 25010 / Aluminum caps: grommet and closed for DOUBLE diffuser 25010
- 25013P-01 / 25013C-01 Tappi bianchi: passacavo e chiuso per DOPPIO diffusore 25010 / White caps: grommet and closed for DOUBLE diffuser 25010
- 25013P-02 / 25013C-02 Tappi neri: passacavo e chiuso per DOPPIO diffusore 25010 / Black caps: grommet and closed for DOUBLE diffuser 25010

FISSAGGIO/FIXING

- 13001-00 Kit 2 staffe simmetriche ox. argento per fissaggio APPLIQUE. / Kit for 2 symmetrical ox. silver brackets for fixing APPLIQUE.
- 13001-01 Kit 2 staffe simmetriche bianche per fissaggio APPLIQUE. / Kit for 2 symmetrical white brackets for fixing APPLIQUE.
- 13001-02 Kit 2 staffe simmetriche nere per fissaggio APPLIQUE. / Kit for 2 symmetrical black brackets for fixing APPLIQUE.
- 14210 Clip in ottone per staffe 13001. / Brass clip for brackets 13001.